

Masport®

WOOD FIRES

VERONA

		NZ	AUST	
Verona	Black	995956	995956	Page 2
Fans	Fan Assy-3 Speed - DE	995370	995370	Page 6
	Fan Assy-Remote Control	998398	998398	Page 7
Flue	150mm Hi Therm - 4m	556099	————	Page 8

Serial Number From 3030911

Month and Year of Manufacture: From August 2003



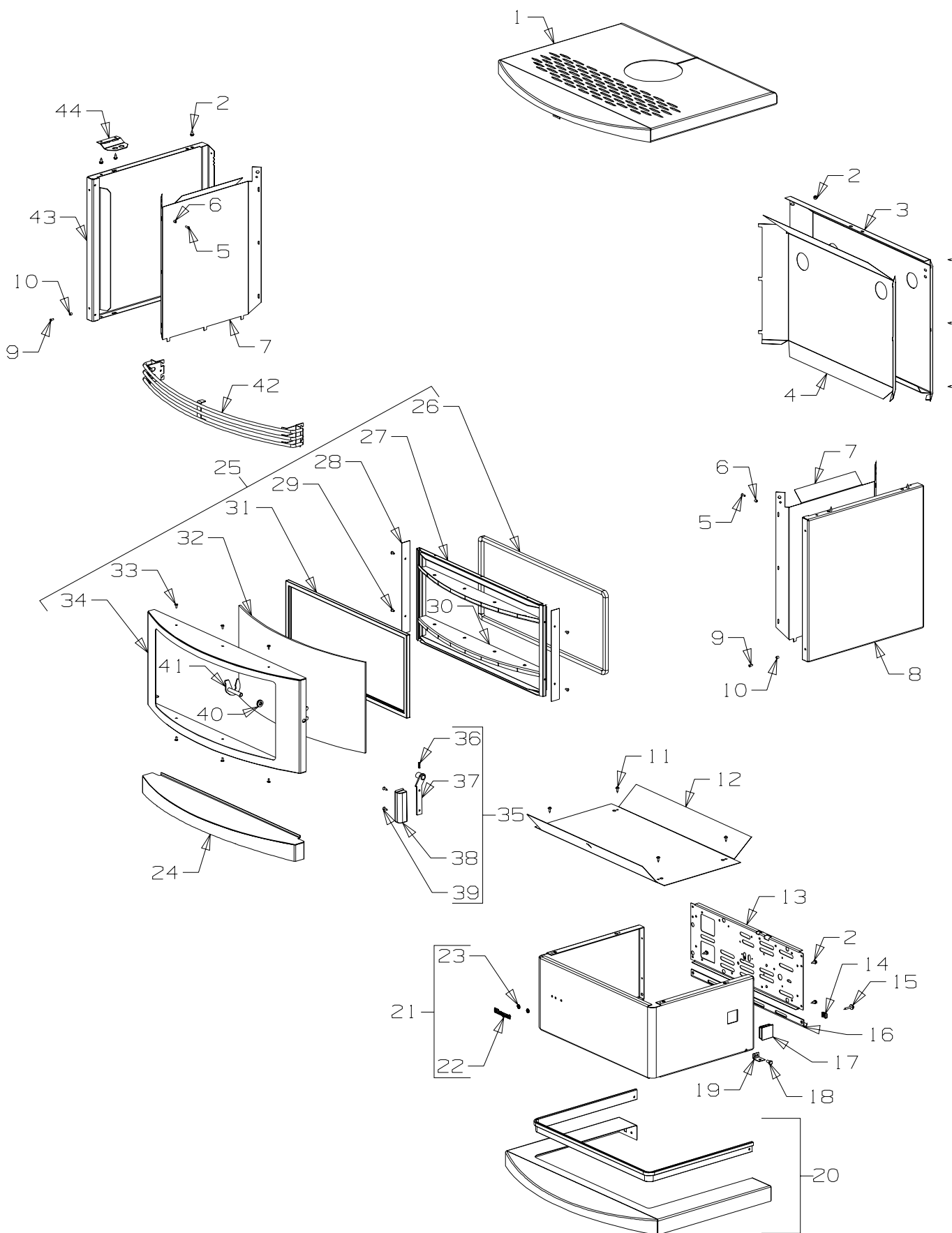



Item No	Part No	Description	Qty	Item No	Part No	Description	Qty
1	795347	Panel-Top - Black	1	24	795350	Panel-Front - Black	1
2	503259	Screw;S/T 10 x .5	19	25	995372	Door Assy Black (incl. items 26-41)	1
3	786823	Panel-Rear - Black	1	26	700755	• Rope, Round 16.0 Glass	1
4	986492	Heatshield-Back	1	27	995299	•Frame Assy-Glass (incl. items 28-30)	1
5	501303	Rivet-Pop 4.0 Dia x 7.9	6	28	995337	• Retainer-End, Glass	2
6	986148	Spacer-Grille	2	29	503627	• Rivet-4.0 Dia	4
7	986121	Heatshield-Side	2	30	995297	• Retainer-Glass	2
8	786828	Panel-Side RH - Black	1	31	995380	• Tape, Flat 6 x 38	1
9	586167	Rivet-Pop 4.0 Dia x 4.8	4	32	795333	• Glass	1
10	986149	Spacer-Front Panel	2	33	503009	• Screw; S/T 8 x .312	10
11	503005	Screw; Pan No.10 x 1/2"	4	34	795349	• Panel-Door - Black (no glass)	1
12	986491	Heatshield-Bottom	1	35	786772	• Handle Assy, Door	1
13	791150	Panel-Pedestal, Back - Black	1	36	503006	• Pin,Tension 4.0 x 16	1
14	503388	Nut-Spire	6	37	986605	• Handle-Assy	1
15	503459	Screw, S/T 12 x 25	6	38	586161	• Handle-Door	1
16	995612	Bracket-Seismic Restraint	1	39	503004	• Screw; CSK No. 8 x 5/8"	2
17	586155	Plug-Switch Hole	1	40	501704	• Washer, Flat 10 x 19 x 1.6	3
18	501959	Screw,Set M6 x 12	9	41	986487	• Latch-Door Assy 10mm	1
19	986413	Bracket-Seismic Restraint	2	42	791573	Grill-Assy - Silver/Black	1
20	995348	Foot Assy - Black	1	43	786825	Panel-Side LH - Black	1
21	794066	Pedestal - Black (incl. item 17, 22-23)	1	44	986147	Brace-Side Panel	1
22	584581	• Badge - Gold	1				
23	503381	• Clip-Starlock, 4 Dia	2				

Bold Text = Assembly
Indented Bullet Points = Item included in Assembly

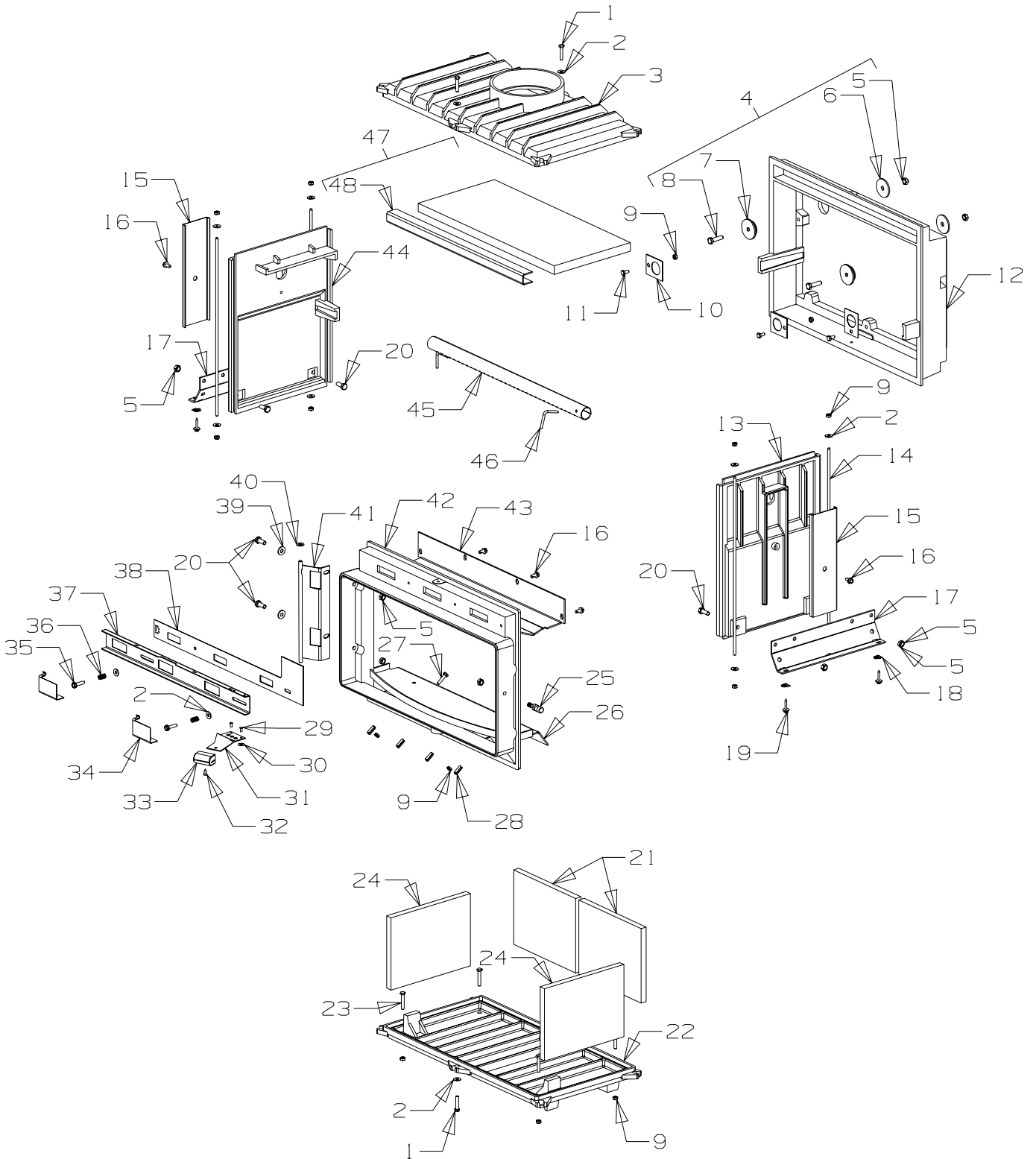



Item No	Part No	Description	Qty	Item No	Part No	Description	Qty
1	501962	Screw, Set M6 x 30	4	29	586167	Rivet-Pop 4.0 Dia x 4.8	4
2	500374	Washer; Flat 1/4" x .63	15	30	500848	Washer; Flat 3/16" x .5	2
3	986302	Firebox-Top	1	31	995356	Extension Slide-Air Inlet	1
4	984090	Plug Assy - 34mm Dia	2	32	503792	Screw; CSK No 8 x 1/2"	1
5	501602	• Nut, M8 HEX (2)	13	33	986162	Knob-Air Control	1
6	502093	• Washer, Flat 8 x 42 x 3.0	2	34	994529	Cover-Air Slide	2
7		NOT AVAILABLE		35	503336	Screw, T/F M6 x 25	2
8	501685	• Screw, Set M8 x 30 HEX	2	36	585223	Spring-Compression, Air Inlet	2
9	501682	Nut, M6 HEX	24	37	987155	Slide-Air Inlet 20 x 50	1
10	984838	Flange-Secondary Air Tube	3	38	995366	Plate, Back-Meter "K" - NZ	1
11	501959	Screw, Set M6 x 12 Hex	9		995329	Plate, Back-Meter "D" - AUST	1
12	786661	Firebox-Back (Incl items 1(2), 2(2), 9(3), 10, 11(3))	1		995625	Plate, Back-Meter - Overnight Burn - NZ	1
13	786646	Firebox-Side RH	1	39	501606	Washer, Flat 8 x 19 x 1.6	2
14	984598	Rod-Tie, M6	4	40	006025	Washer; Flat 5/16"	1
15	786146	Cover-Secondary Air	2	41	786664	Hinge Assy (Incl items 5(2), 20(2))	1
16	503003	Screw; S/T 1/4" x .5 Hex	6	42	786660	Firebox-Front	1
17	986123	Bracket-Mounting, Cabinet	2	43	795338	Deflector-Primary Air	1
18	503388	Nut-Spire	4	44	786645	Firebox-Side LH	1
19	503459	Screw, S/T 12 x 25	6	45	995288	Tube-Secondary Air, 33 x 3.5	1
20	501597	Screw, Set M8 x 20 HEX	6	46	586439	Pin-Retaining, Secondary Air Tube	1
21	794065	Board-Firebox, Back - 15mm	2	47	786109	Board-Firebox, Top 20 x 215 x 470	1
22	786681	Firebox-Bottom	1	48	993048	•Channel-Baffle Reinforcer	1
23	501815	Screw, Set M6 x 35	4		986373	Board-Firebox, Top 20 x 215 x 470 (5 pack)	1
24	794064	Board-Firebox, Side - 15mm	2		993048	•Channel-Baffle Reinforcer	5
25	586482	Pin-Door Latch	1				
26	995339	Ash Retainer	1				
27	501963	Screw, Set M6 x 25 HEX	2				
28	503008	Pin, Tension 8.0 x 20	4				
	795366	Slide-Air Complete "K" - NZ (incl. items 29-33, 35-36, 38)	1				
	795366	Slide-Air Complete "D" - Aust (incl. items 29-33, 35-36, 38)	1				

Bold Text = Assembly
Bullet Points = Item included in Assembly



Three Speed Fan - Double End

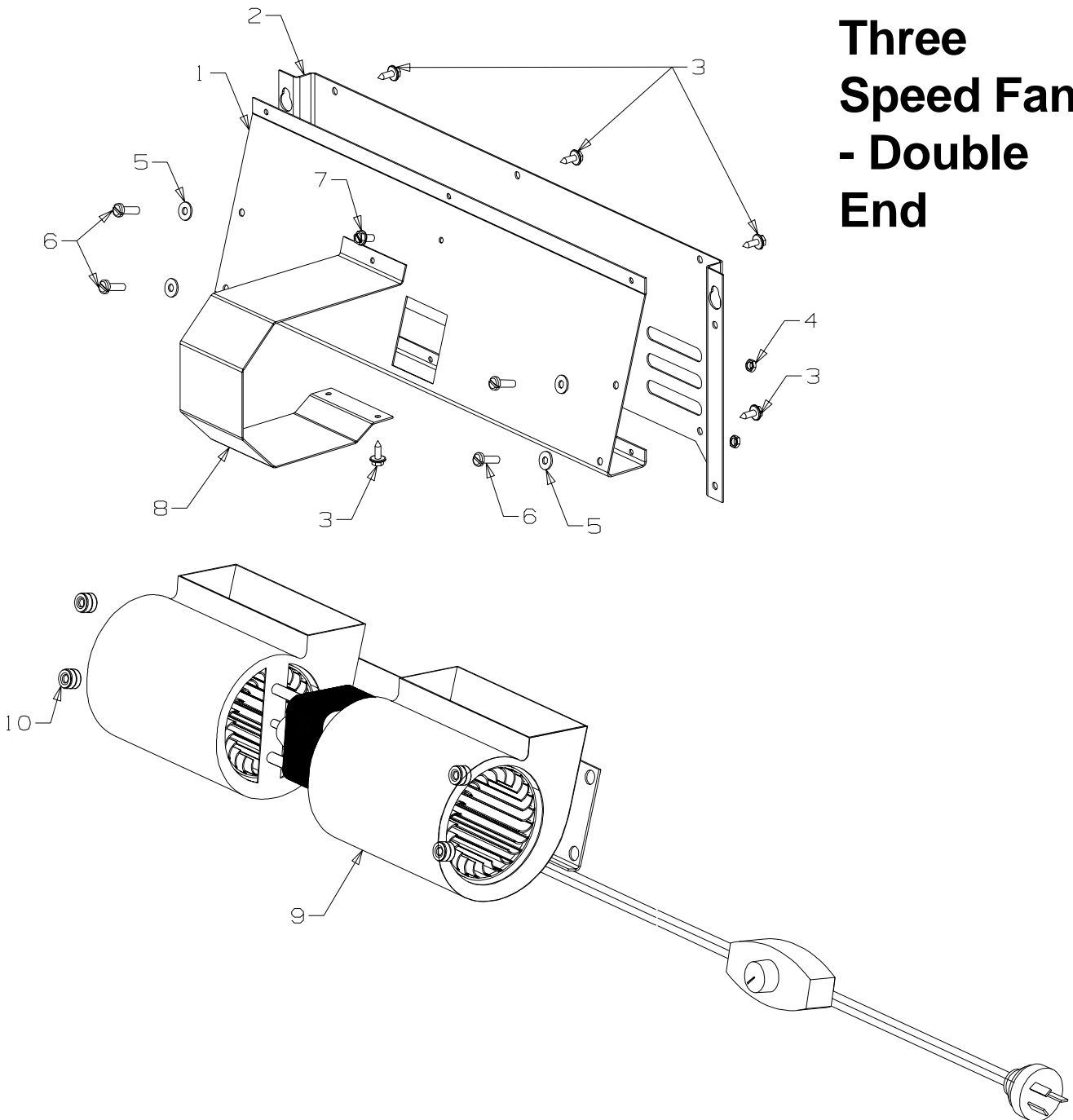

Part No. 995370 Black

Item No	Part No	Description	Qty	Item No	Part No	Description	Qty
1	995369	Panel-Mounting, Fan	1	9	786125	Fan - 3 Speed Double End Incl. Cord Swith	1
2	995368	Panel-Rear, Fan - Black	1	10	503671	Grommet, Fan 14mm OD x 6mm ID	4
3	503630	Screw, S/T 10 x .4	10			NOT ILLUSTRATED	
4	503511	Nut, M5 Hex	4				
5	500848	Washer; Flat 3/16" x .5	4				
6	501580	Screw, Pan M5 x 16	4				
7	501110	Screw; S/T 6 x .25	1				
8	995367	Cover-Fan Motor	1		503054	Tie-Nylon Cable	1

When ordering PLEASE QUOTE PART NUMBER & Description, NOT Illustration No.
Determine right or left hand side from standing in viewing position



Fan Assy - Remote Control

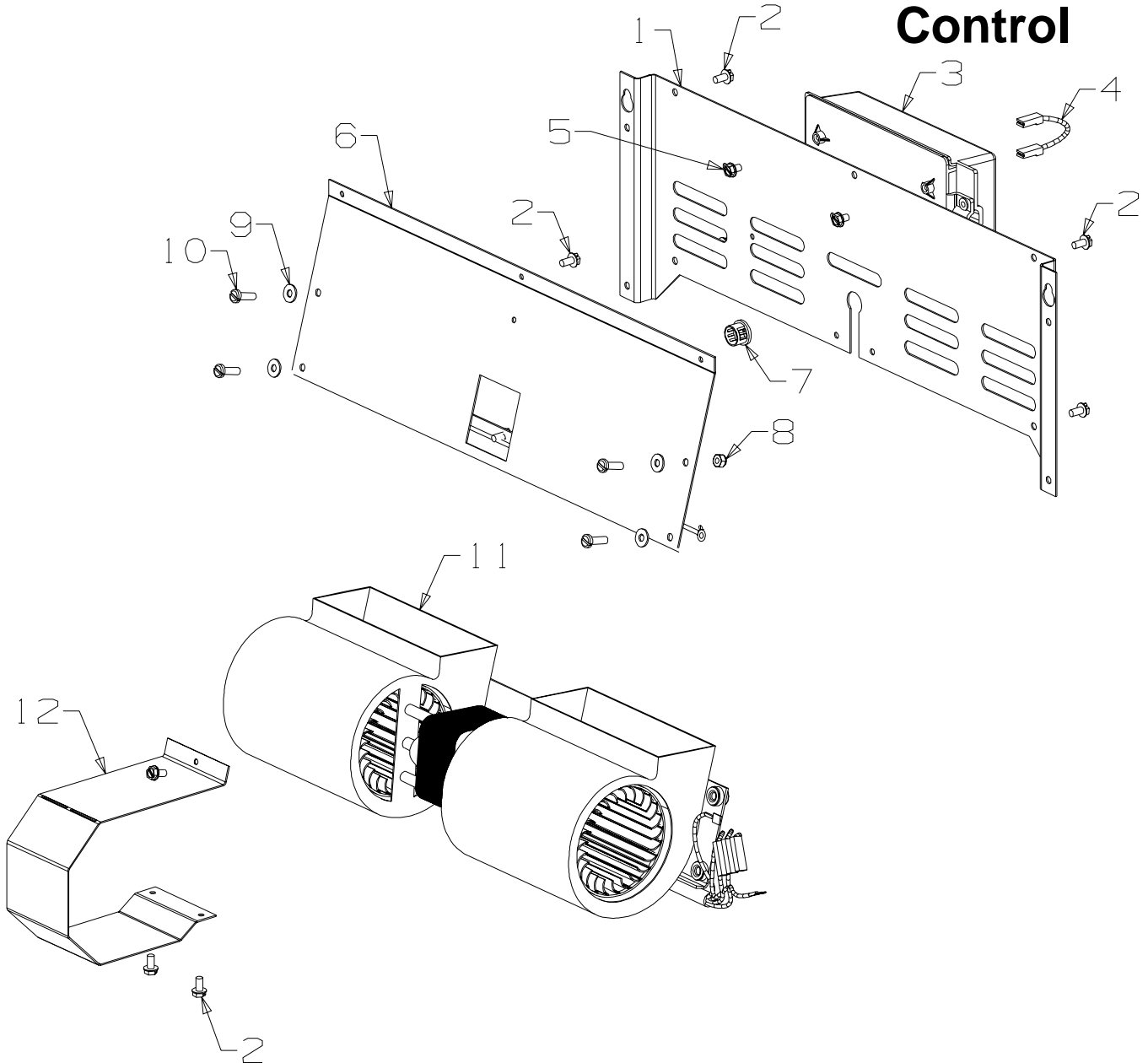

Part No. 995398 Black

Item No	Part No	Description	Qty	Item No	Part No	Description	Qty
1	995368	Panel-Rear,Fan - Black	1	10	501580	Screw, Pan M5 x 16	4
2	503630	Screw; S/T 10 x .4	11	11	786732	Fan-3 Speed Double End	1
3	595397	Circuit Board-Remote	1	12	995367	Cover-Fan Motor	1
4	591287	Lead-P/C Board	1				
5	503259	Screw; S/T 10 x .4	2			NOT ILLUSTRATED	
6	995369	Panel-Mounting, Fan	1		503054	Tie-Nylon Cable	1
7	586734	Bush-Plastic	1		588068	Loom-3 Pin, Fan V 75	1
8	503511	Nut, Nyloc M5	4		595396	Remote Control-Handpiece	1
9	500848	Washer; Flat 3/16"	4				

When ordering PLEASE QUOTE PART NUMBER & Description, NOT Illustration No.
Determine right or left hand side from standing in viewing position



NZ Only



150mm Flue Kit

(to suit Horizon, LE 2000, Siena, LE 3000, LE 5000, **Verona**, Utopia)

Contains:

- 3 x 1200mm lengths Flue
- 1 x 1200mm length Outer / Inner Heat Shield Combination
- 1 x 600mm Outer Shield Extension
- 1 x Anti Down Draught Cowl
- 1 x Casing Cover
- 1 x top Flue Spacer Bracket
- 1 x Ceiling Plate
- 1 x Packet screws & Ceramic Spacers

Note: Flue Reflector is required for standard installations
- Part Number 551481

Part No: 556099



Item No	Part No	Description	Qty
		NOT ILLUSTRATED	
	585416	Bag-Fire Bedding Sand (Firebox)	1
	584048	Tube-Maniseal (Firebox)	1
	595151	Owners Manual	1
		ASSEMBLYS	
	786775	Firebox Assembly	1
		ACCESSORIES	
	586044	Hot Water Booster	1
	995371	Hot Water Booster Kit	1
	586202	Paint, Touch Up - Black	1